

The Modal Research Design for SFT
Application in Face Perception:
Conjunctive/Disjunctive-rule Stimulus Structures
(AND/OR)
&
a Novel Signature of Holistic Face Perception:
“Snake Wiggle”.

Mario Fifić[†]

Daniel Little[‡]



[†] Grand Valley State University

[‡] The University of Melbourne

The holistic hypothesis: Objects are perceived as whole entities and not as a sum of independent features

Analytic, or feature-based

hypothesis: Objects are perceived as a simple sum of independent features

Systems Factorial Technology

SFT

Systems factorial technology (SFT)

- Donders (1868), Subtraction method, pure insertion
- Sternberg – Additive factor method (1969)
- Development of mental networks (Schweickert, 1978, 1982), Townsend & Schweickert's *trichotomy* method (1985, '89), Schweickert, Georgini and Dzhafarov 2000.
- Townsend et al stochastic modeling theory (1984, '83, 95).
- Validation and extensions of SFT (Fific, 2006; Townsend & Fific, 2004; Fific, Nosofsky, Townsend, 2008; Fific, Townsend & Eidels, 2008)

SFT designs in a nutshell

- The number independent variables = the number of processes under examination, n .
- Each independent variable should vary between binary values of saliency. The saliency is operationally defined as a manipulation that selectively influences a single process of interest, such that the process is speeded up (H=high saliency) or slowed down (L=low saliency).
- The levels of all independent variables should be factorially combined, The total number of experimental conditions is equal to 2^n .

A catalog of mental architectures

Signatures

SIC

Architecture flow diagram

A
Serial
Self-terminating

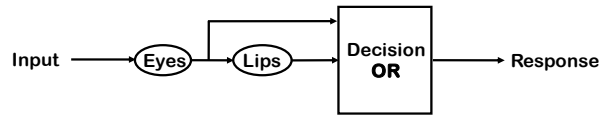

Analytic

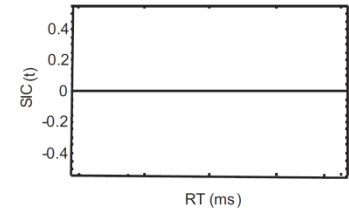

B
Serial
Exhaustive

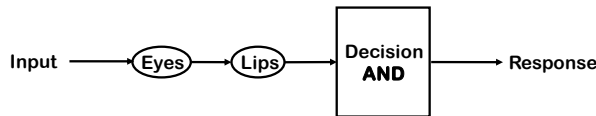

**Analytic/
Holistic**

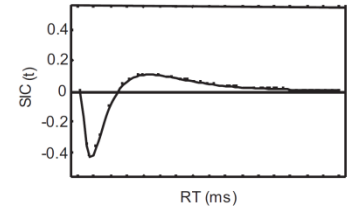

C
Parallel
Self-terminating

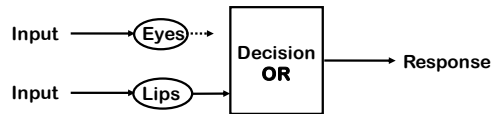

Analytic

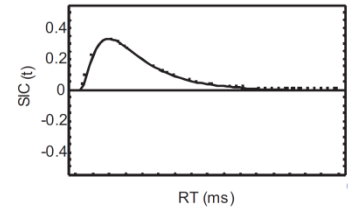

D
Parallel
Exhaustive

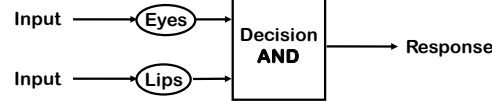

**Analytic/
Holistic**

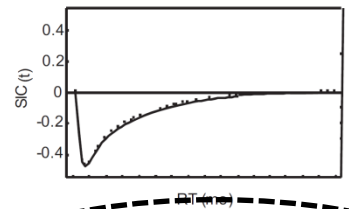

E
Coactive

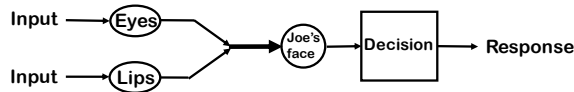

**Strong
Holistic**

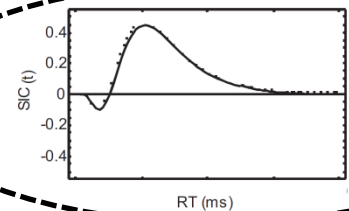

Diagnostic SFT signatures: MEAN INTERACTION CONTRAST:

$$\text{MIC} = [\text{RT}(\text{LL}) - \text{RT}(\text{LH})] - [\text{RT}(\text{HL}) - \text{RT}(\text{HH})]$$

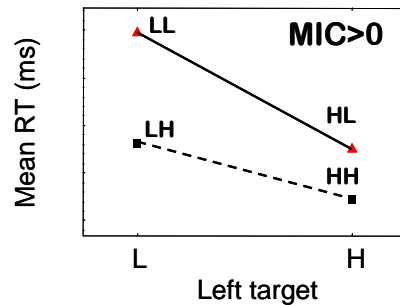
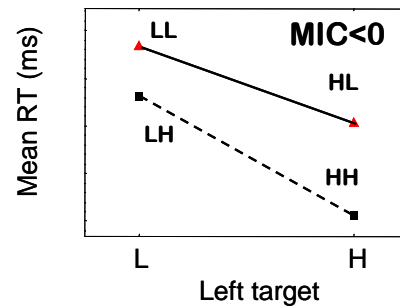
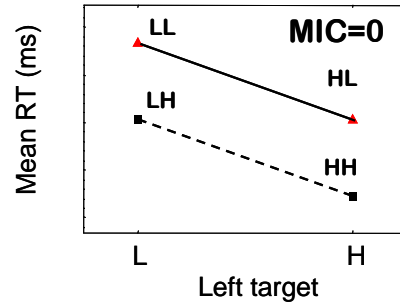

Diagnostic SFT signatures: MEAN INTERACTION CONTRAST:

$$\text{MIC} = [\text{RT}(\text{LL}) - \text{RT}(\text{LH})] - [\text{RT}(\text{HL}) - \text{RT}(\text{HH})]$$

Architecture	Stopping Rule	MIC
Serial	Self Terminating	0, Additive
Serial	Exhaustive	0, Additive
Parallel	Self Terminating	> 0, Overadditive
Parallel	Exhaustive	< 0, Underadditive
Coactive		> 0, Overadditive

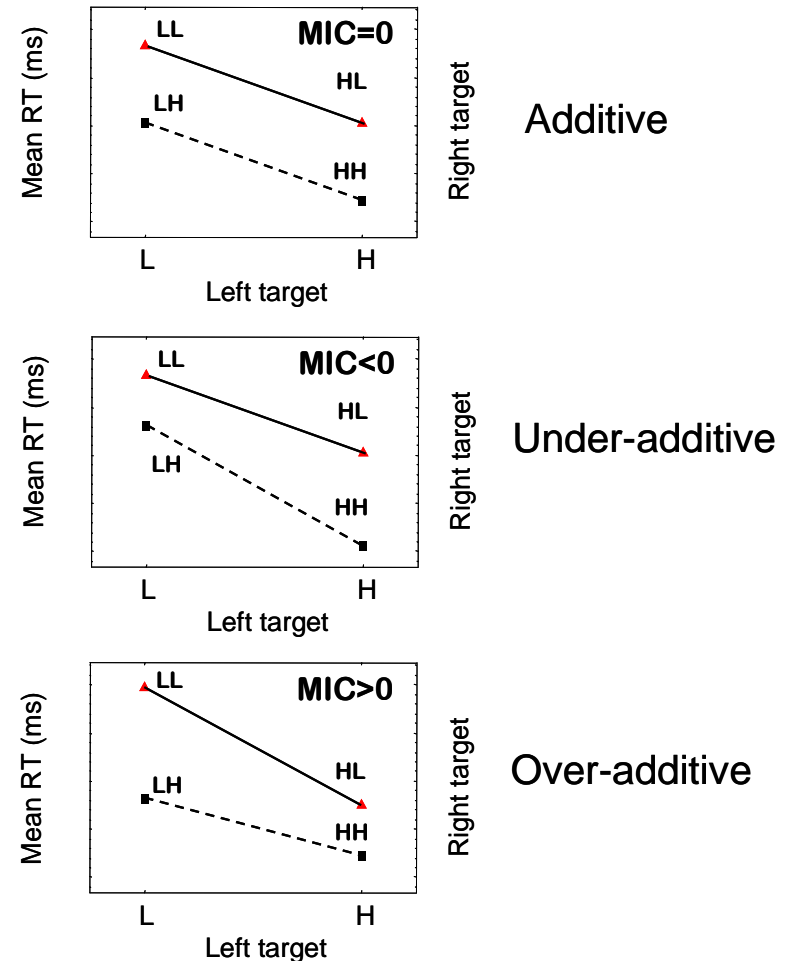

Diagnostic SFT signatures:
SURVIVOR-INTERACTION CONTRAST (SIC)
FUNCTION

$$\text{SIC}(t) = [S_{LL}(t) - S_{LH}(t)] - [S_{HL}(t) - S_{HH}(t)]$$

- Analogous to MIC function:

$$\text{MIC} = [\text{RT}(LL) - \text{RT}(LH)] - [\text{RT}(HL) - \text{RT}(HH)]$$

Note:

The integral of the SIC is just the MIC.

SFT

A tutorial about how SFT could be applied
on two processes.

THE FACTORIAL PARADIGM

Experimental control over the process' saliency

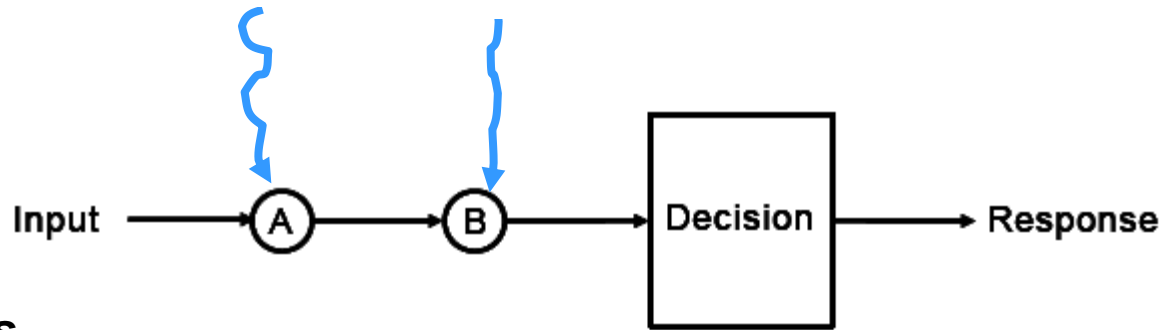
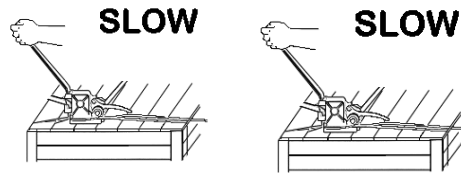

Factorial Conditions

LL

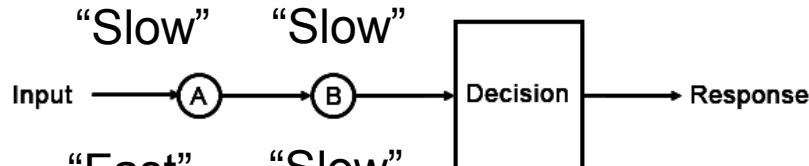

HL

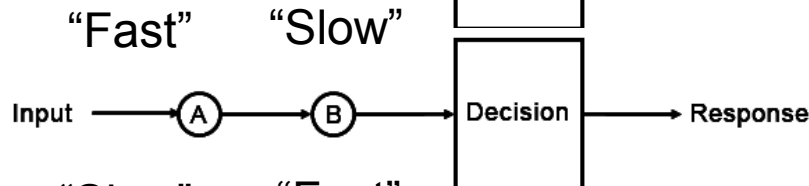

LH

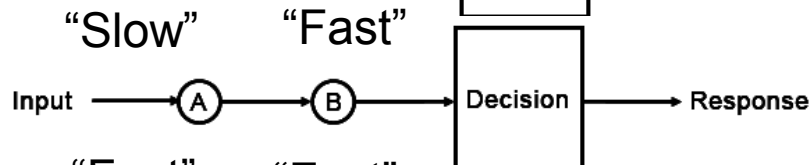

HH

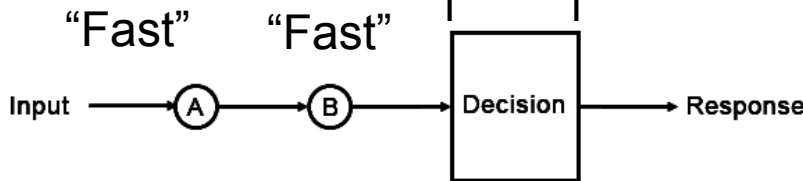

Tutorial: how to calculate the survivor interaction contrast (SIC) function

Conjunctive-rule classification "AND"

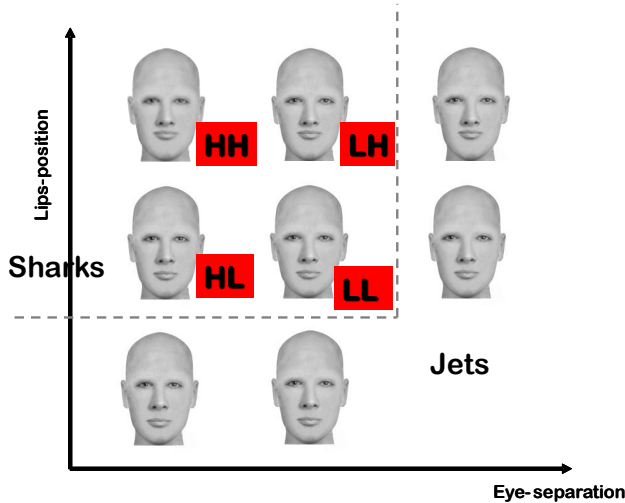

Reaction time histograms

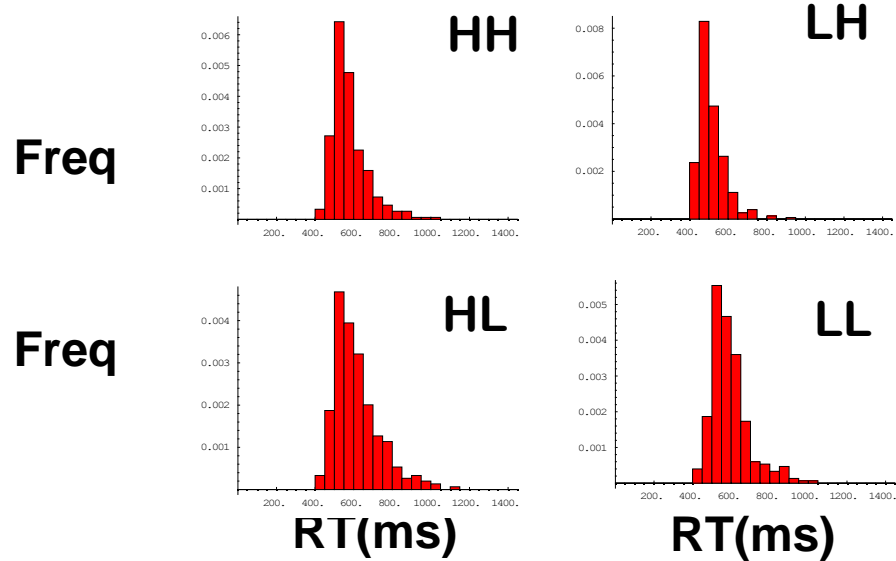

Reaction time Survivor functions

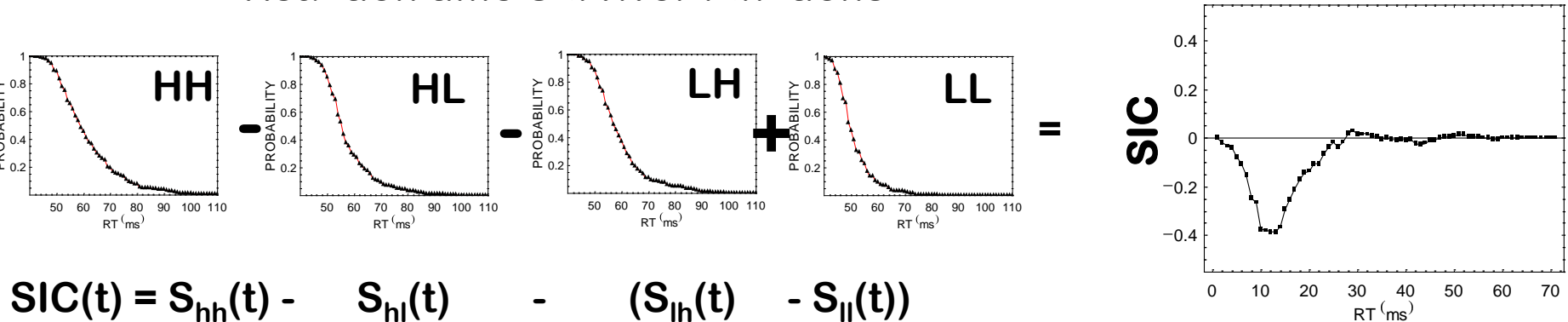

$$SIC(t) = S_{hh}(t) - S_{hl}(t) - (S_{lh}(t) - S_{ll}(t))$$

SFT applied on facial features

- SFT approach could be applied on (facial) features varying on continuous stimulus dimensions
- Example: Configural second-order facial features, such as eye separation, or nose position
- The disjunctive and conjunctive-rule stimulus structures, so called OR and AND designs.

Disjunctive and conjunctive-rule stimulus structures

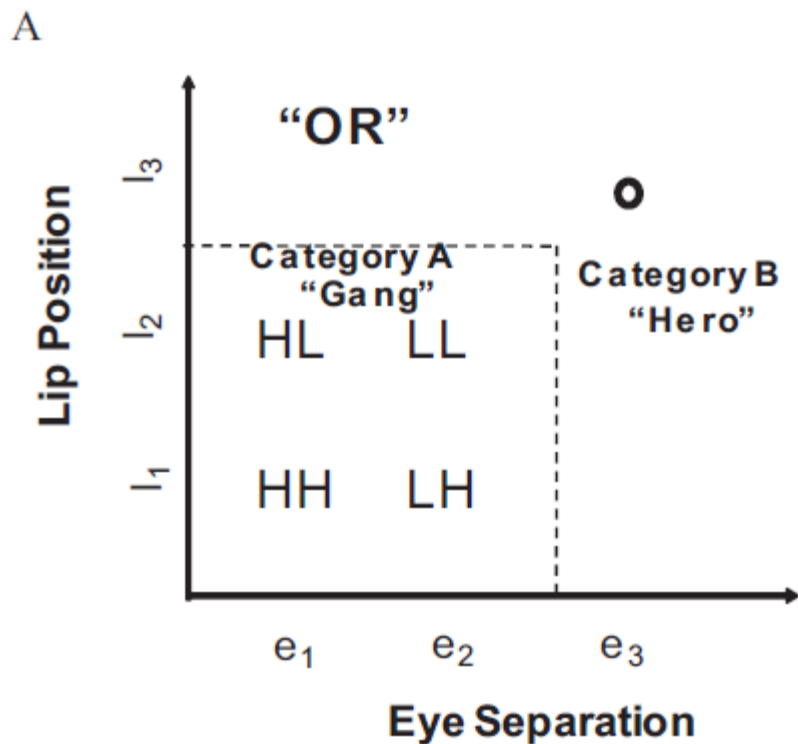

“Analytic friendly”
(permits early termination
in processing)

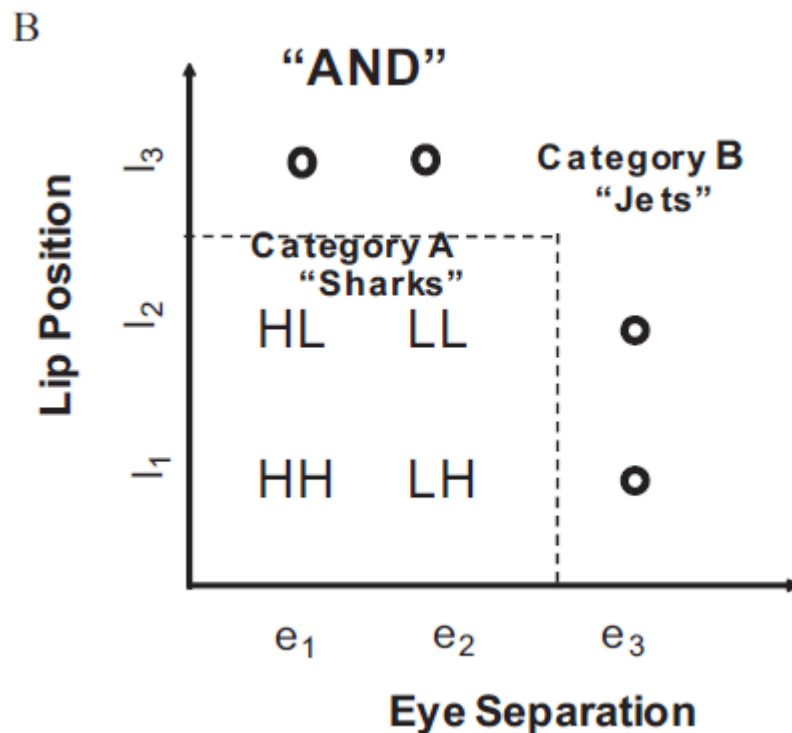

“Holistic friendly”
(requires exhaustive processing
of Sharks)

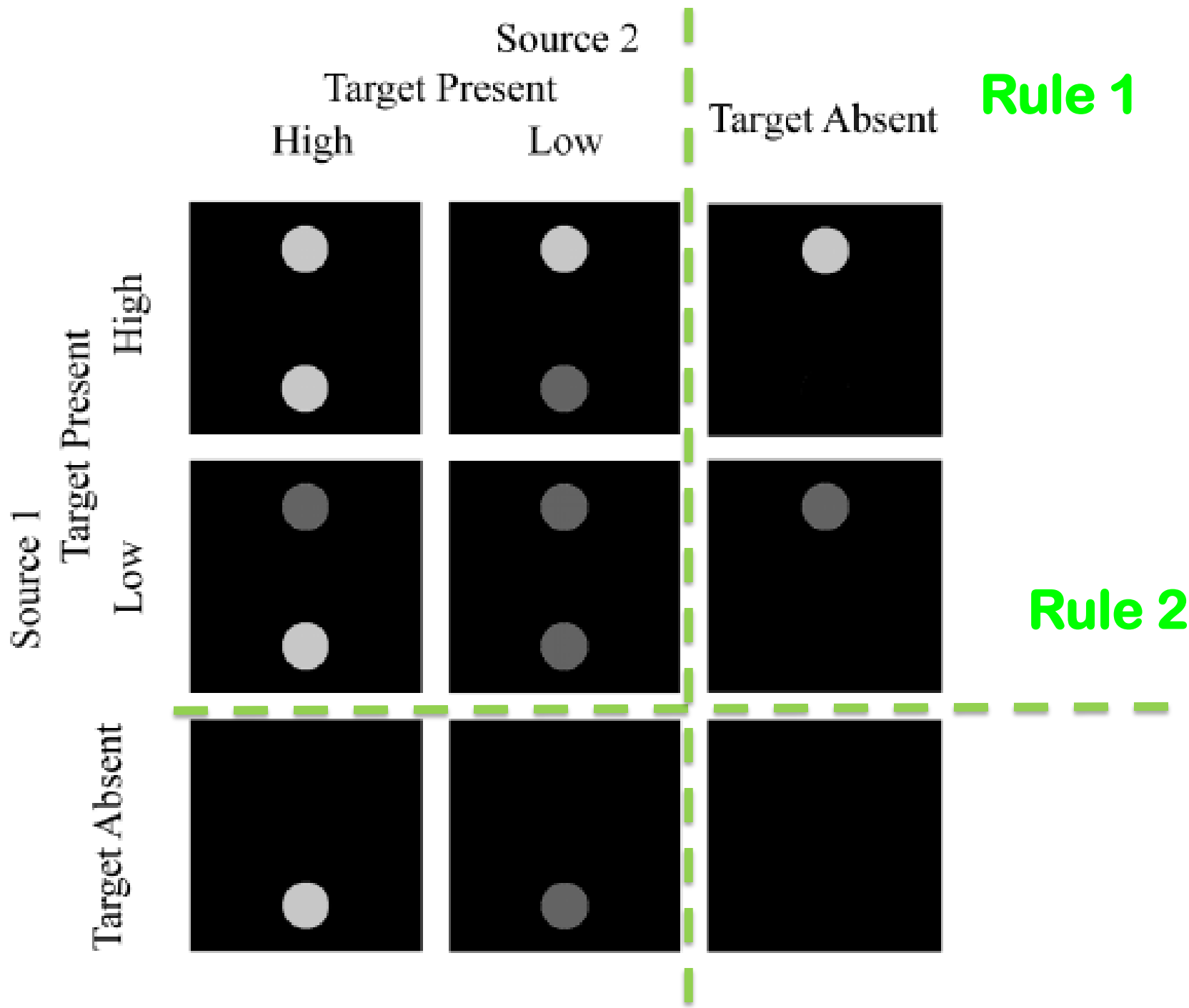

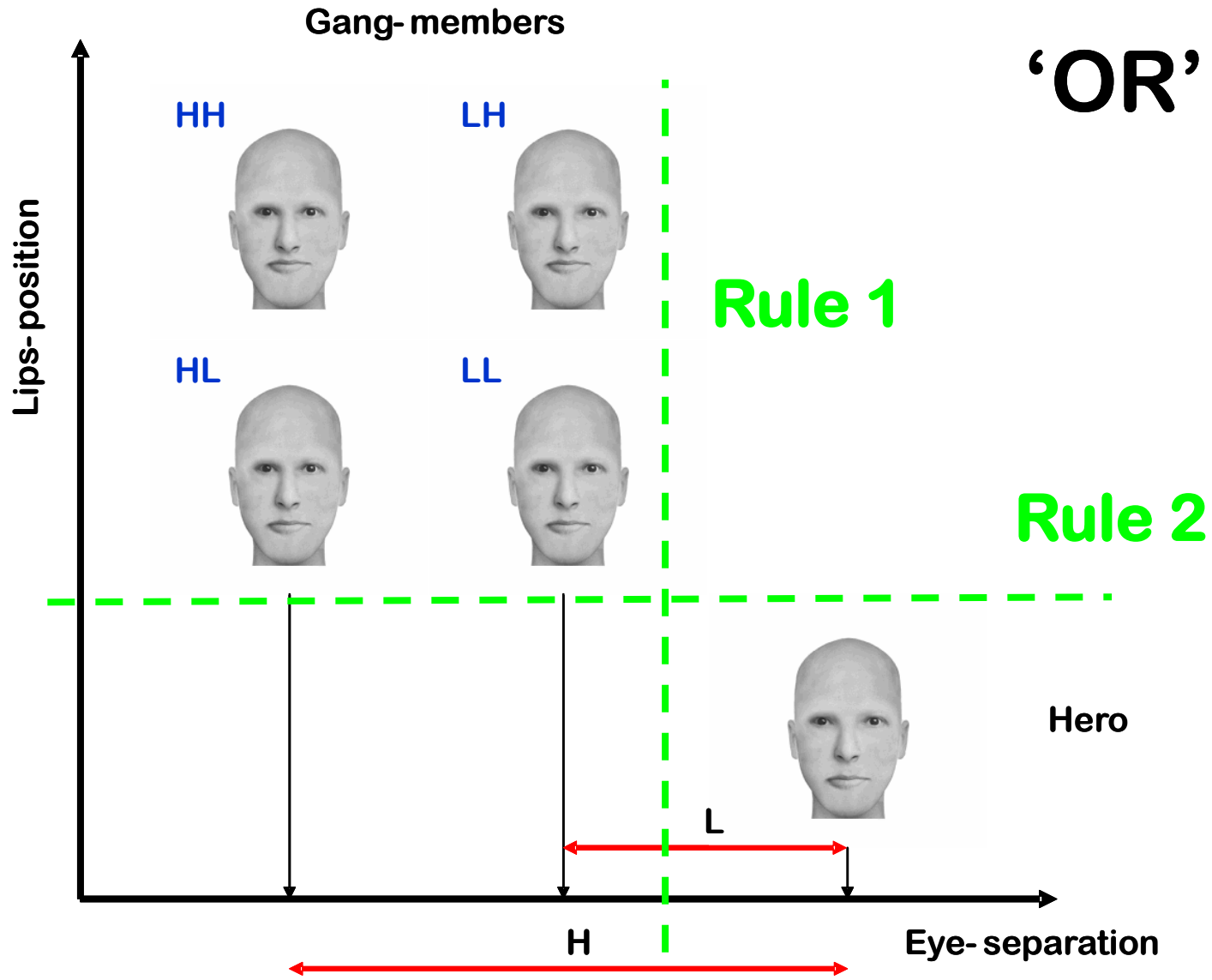

Disjunctive-rule stimulus structures

Observed SIC signatures

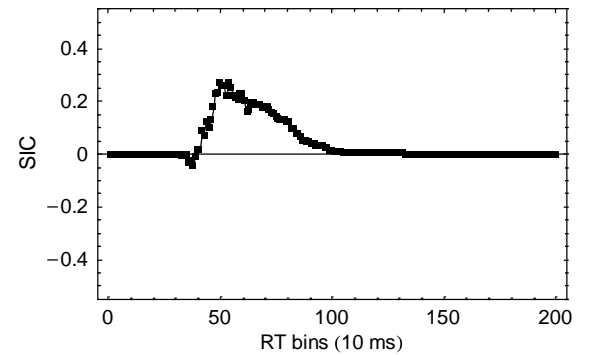
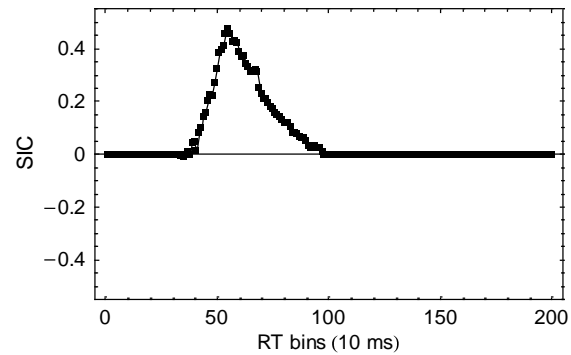
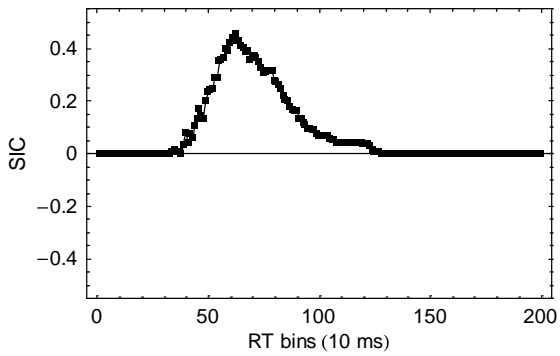

A catalog of mental architectures

Signatures

SIC

Architecture flow diagram

A
Serial
Self-terminating

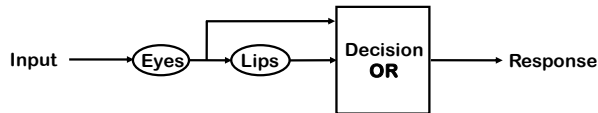

Analytic

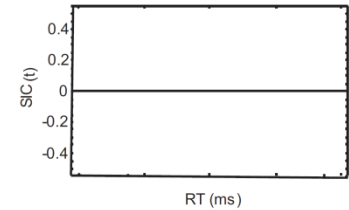

B
Serial
Exhaustive

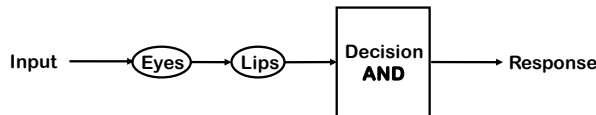

**Analytic/
Holistic**

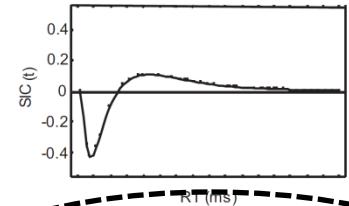

C
Parallel
Self-terminating

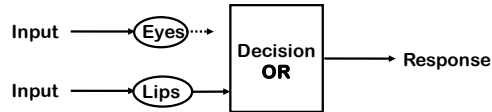

Analytic

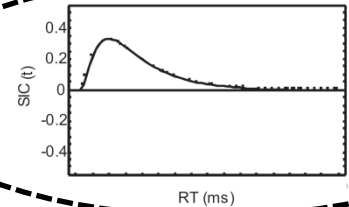

D
Parallel
Exhaustive

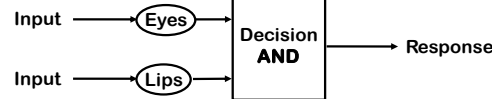

**Analytic/
Holistic**

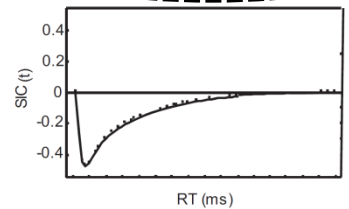

E
Coactive

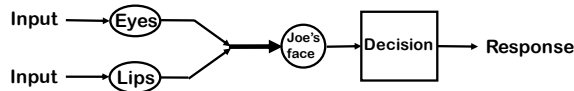

**Strong
Holistic**

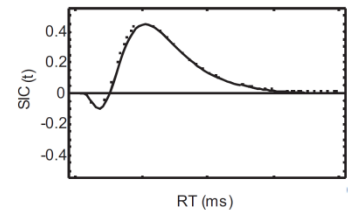

“OR” Disjunctive-rule stimulus structures

Observed SIC signatures

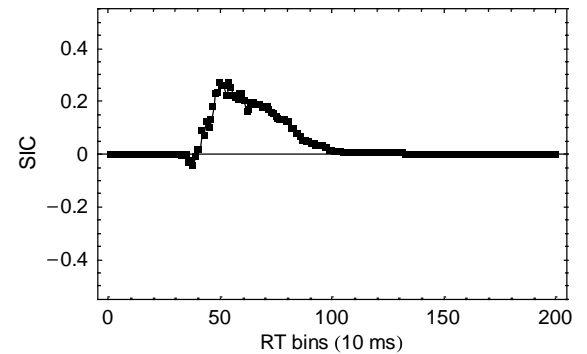
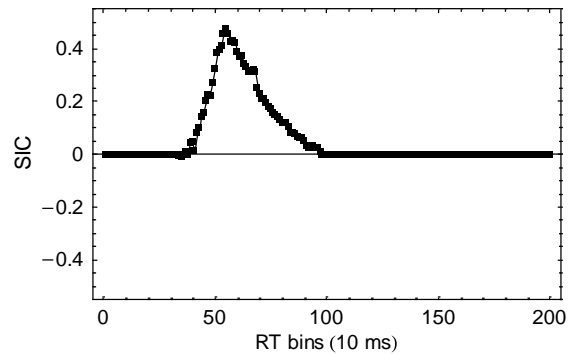
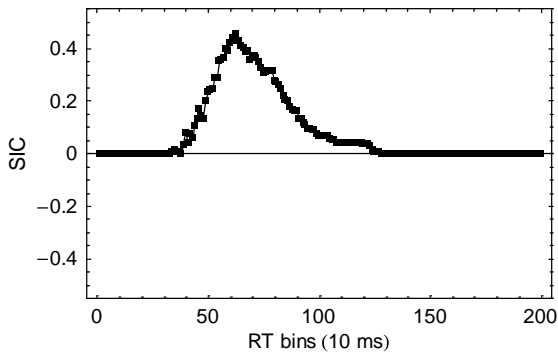

Conclusion: A parallel self-terminating mental architecture

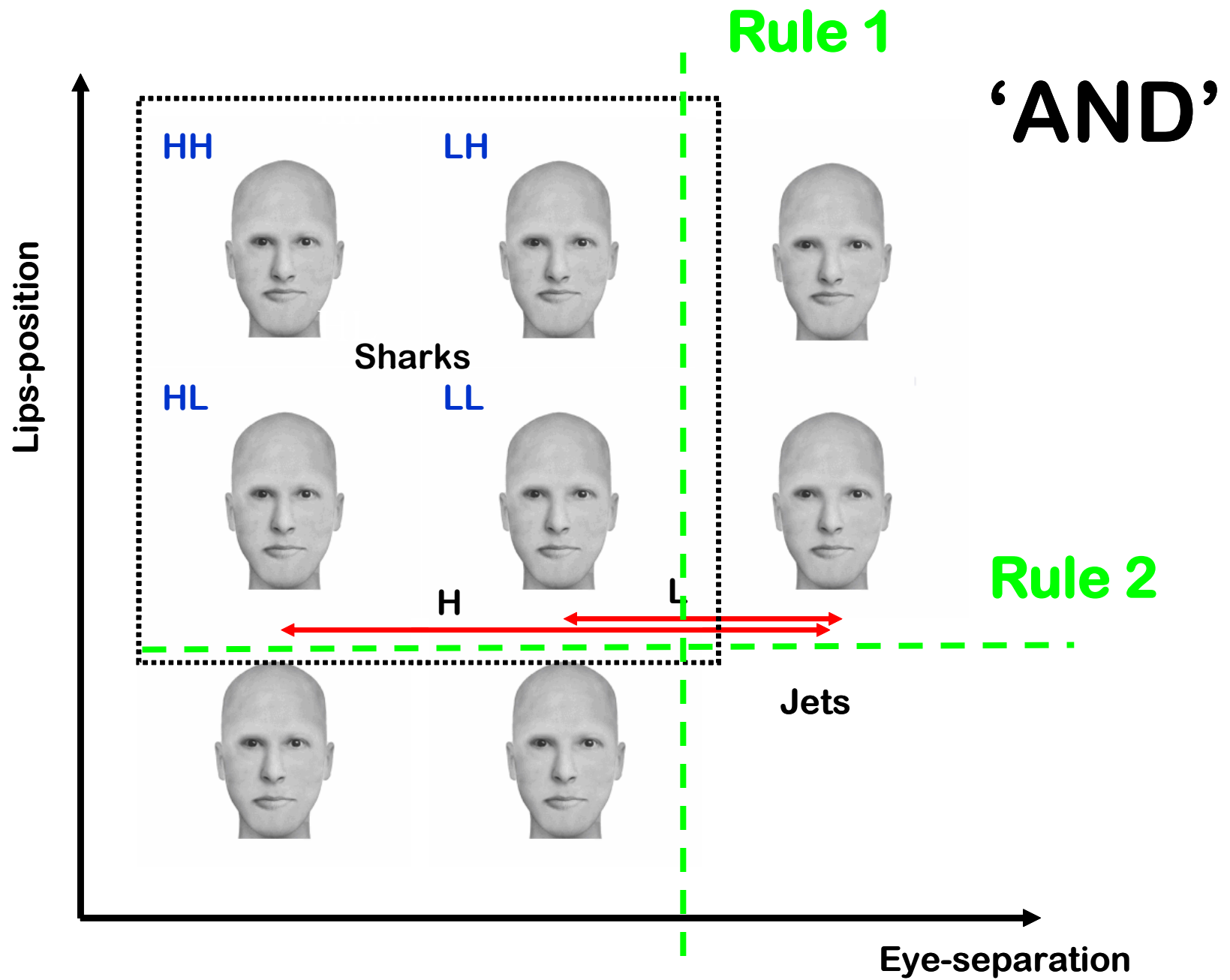

“AND” Conjunctive-rule stimulus structures



Observed SIC signatures

Participant 1

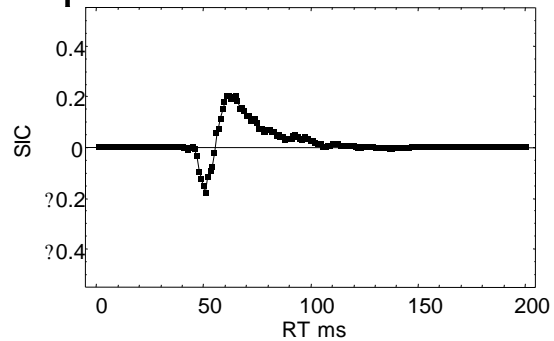

Participant 2

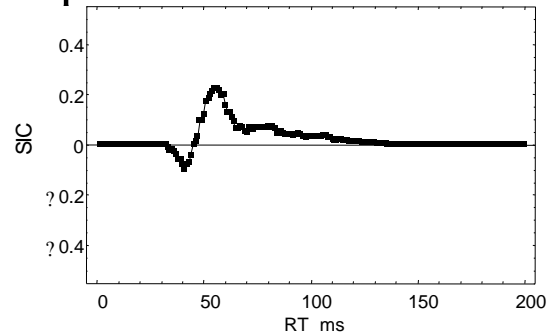

Participant 3

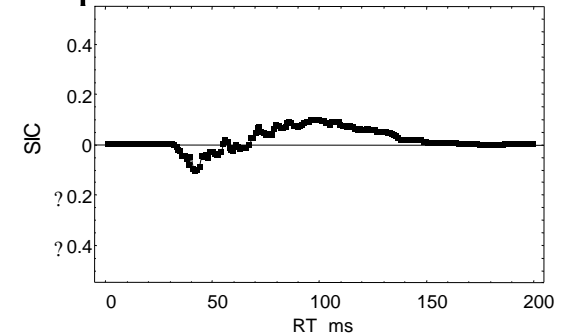

A catalog of mental architectures

Signatures

SIC

Architecture flow diagram

A
Serial
Self-terminating

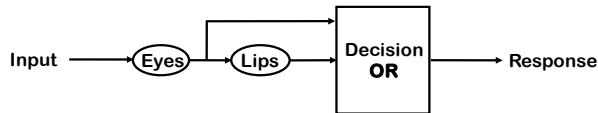

Analytic

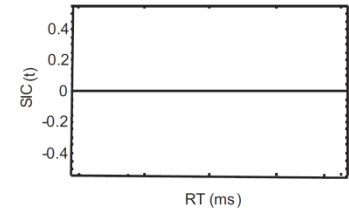

B
Serial
Exhaustive

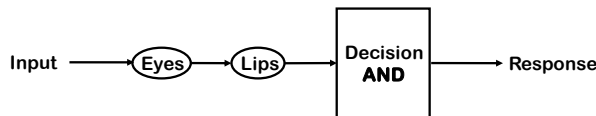

**Analytic/
Holistic**

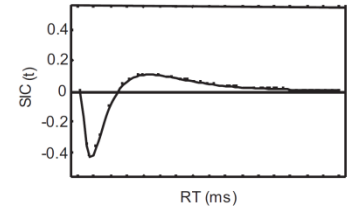

C
Parallel
Self-terminating

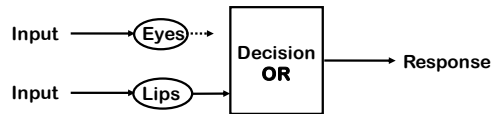

Analytic

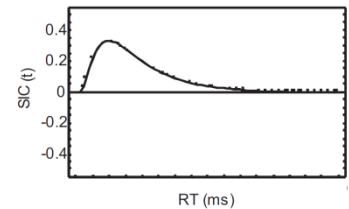

D
Parallel
Exhaustive

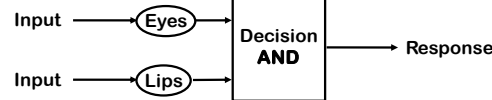

**Analytic/
Holistic**

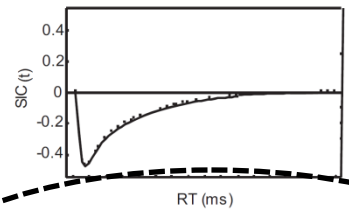

E
Coactive

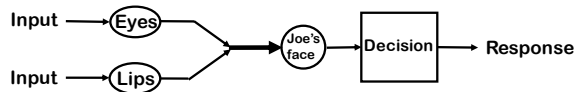

**Strong
Holistic**

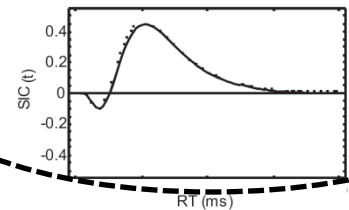

“AND” Conjunctive-rule stimulus structures



Observed SIC signatures

Participant 1

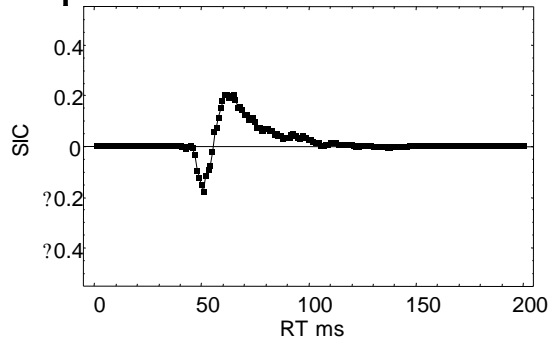

Participant 2

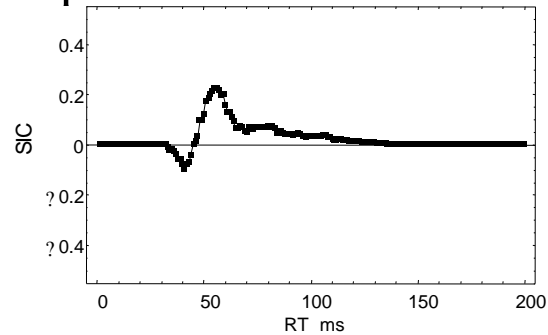

Participant 3

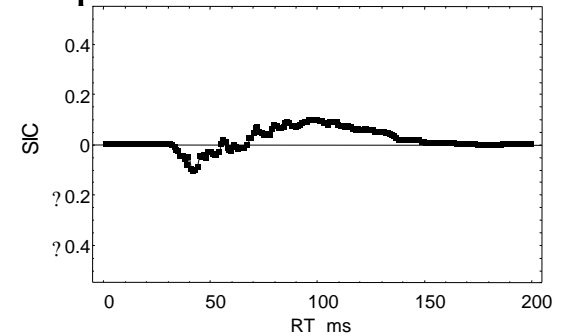

Conclusion: A coactive mental architecture

The task

Conjunctive-rule classification “AND”

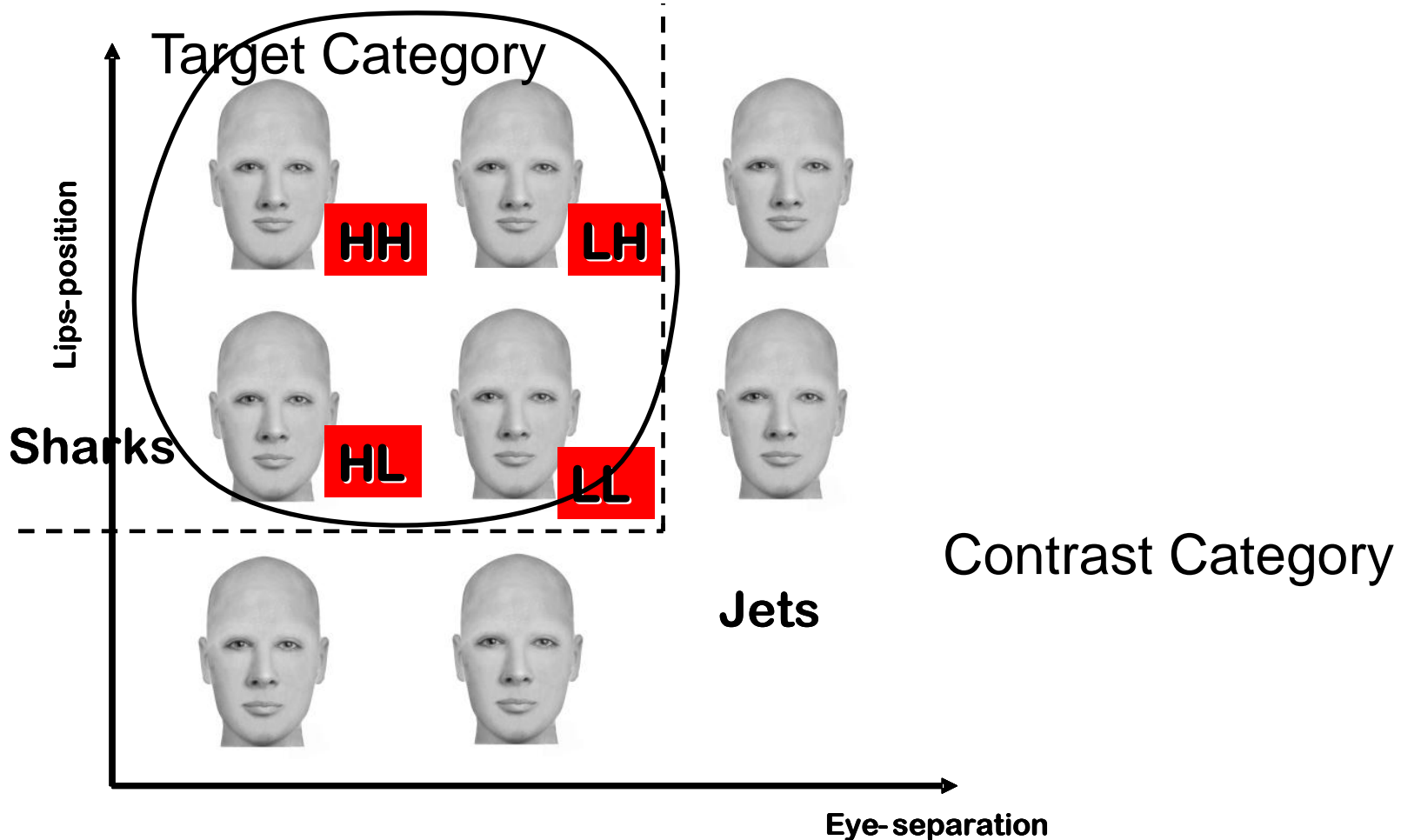

(Fific & Townsend, 2010)

Signatures of Holistic perception

- Gestalt laws: proximity similarity by inducing perceptual effects (Sarris; Overvliet, Krampe & Wagemans)
- Pop-out effect (Pomerantz; Eidels)
- Part to whole paradigm (Donnelli; Tanaka & Farah; Bierman)
- Garner Task (Kimchi)
- Superiority effects (Pomerantz)
- Thatcher faces illusion: Grotesqueness (Wenger)
- Face inversion (Bartlett, Innes-Ker)
- Unitization (Goldstone, Lightfoot & Shiffrin, Blaha)
- Scrambled faces vs Normal
- Neural Responses (Peterson, Palmeri)
- Context effect (Palmer, Kimchi)
- **Super capacity index** (Townsend, Eidels, Blaha, Little)
- **Coactivation signature** (Colonus, Little, Fific, Nosofsky, Townsend; Houpt)

Part-to-whole paradigm x SFT x AND design

Empirical evidence:

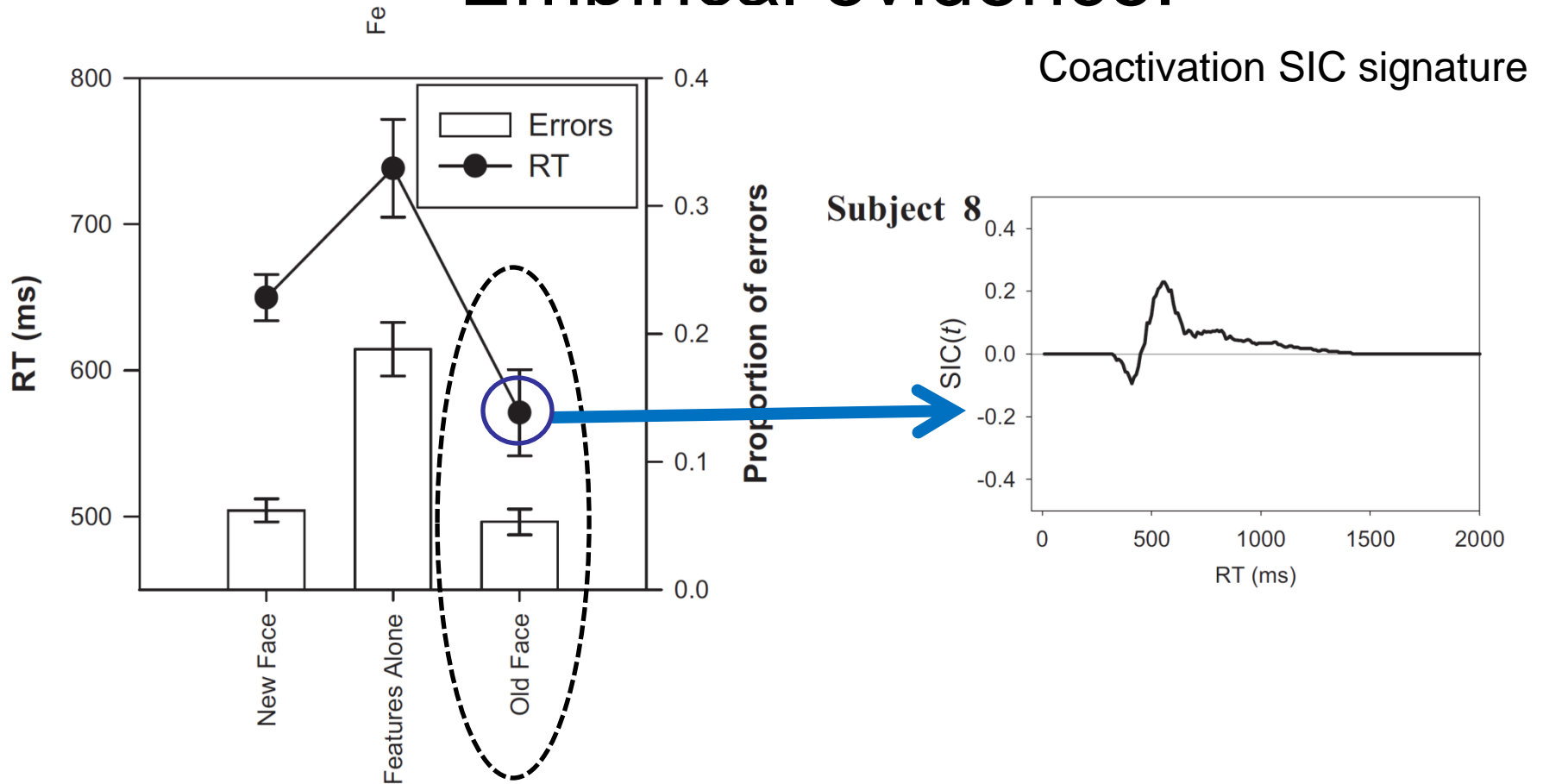

(Fific & Townsend, 2010)

- Can we provide a strong validation of such signature?

New signature of holistic perception

- Dynamical SIC signature

The signature “Snake Wiggle”

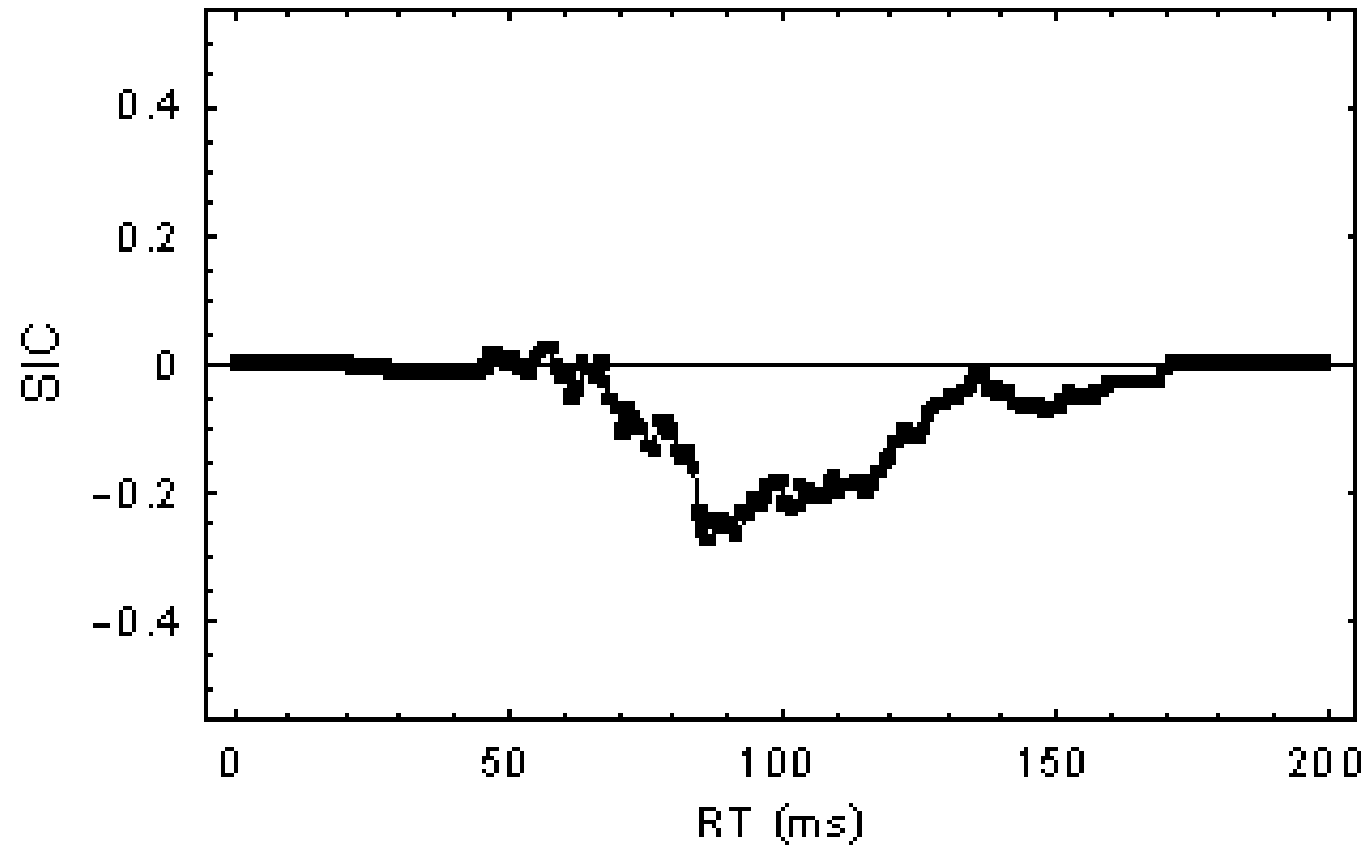

The “Snake Wiggle” signature

Session 1-2

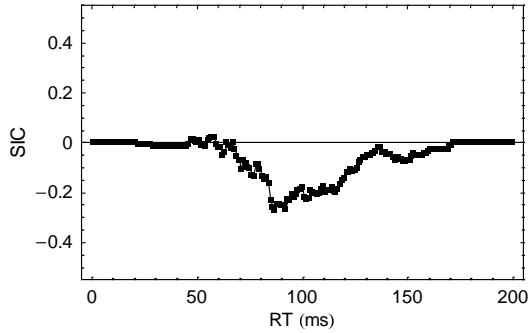

Session 3-4

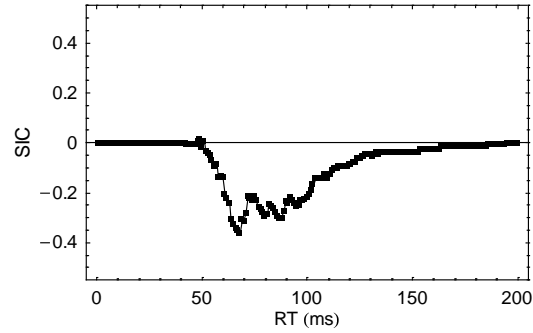

Session 5-6

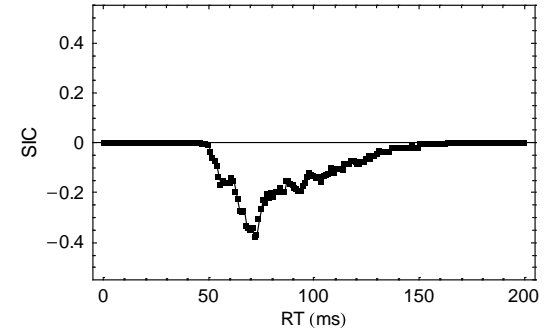

Session 7-8

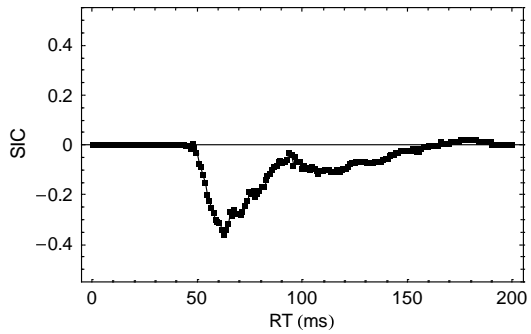

Session 9-10

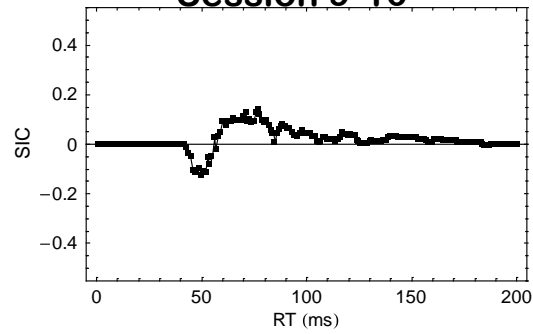

Session 11-12

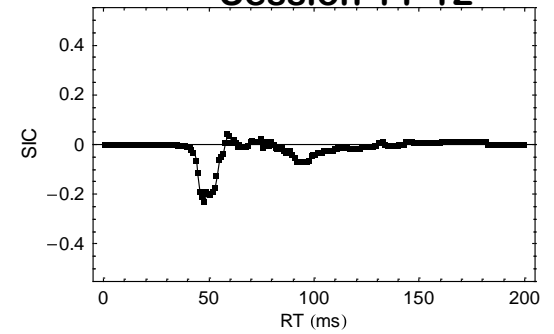

Session 13-14

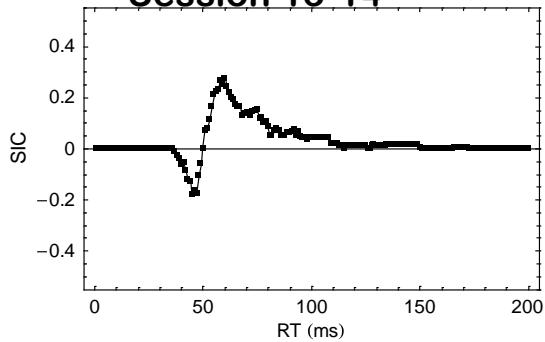

Session 15-16

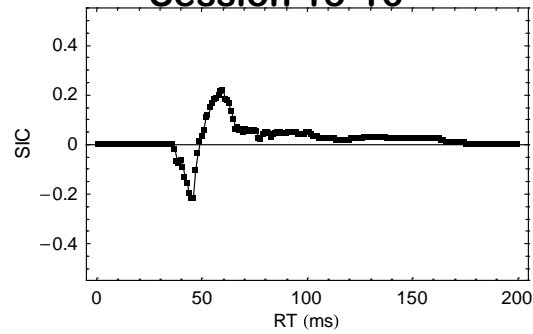

Session 17-18

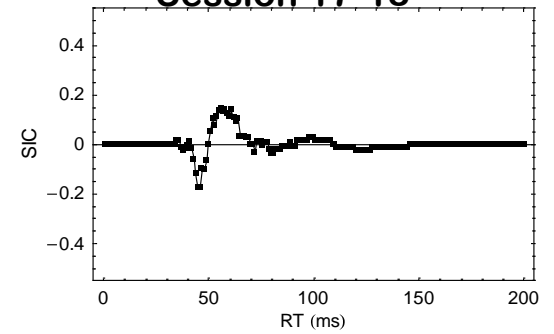

The signature “Snake Wiggle”

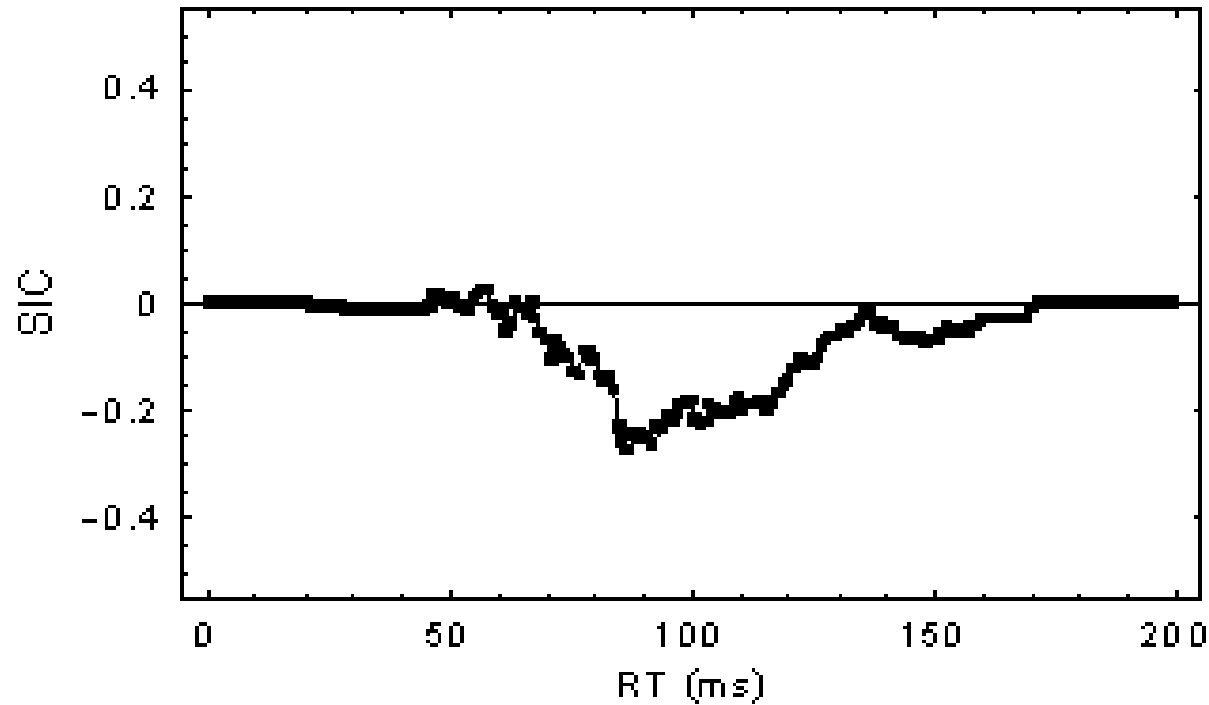

The signature “Snake Wiggle”

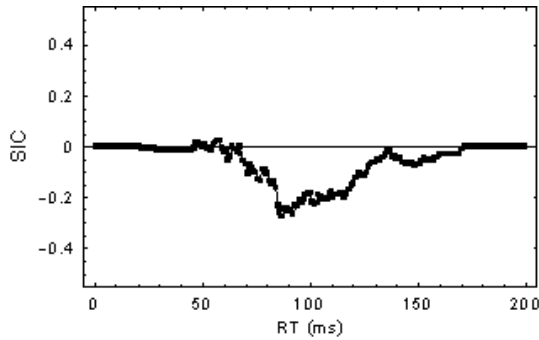

**The total area
under the curve**

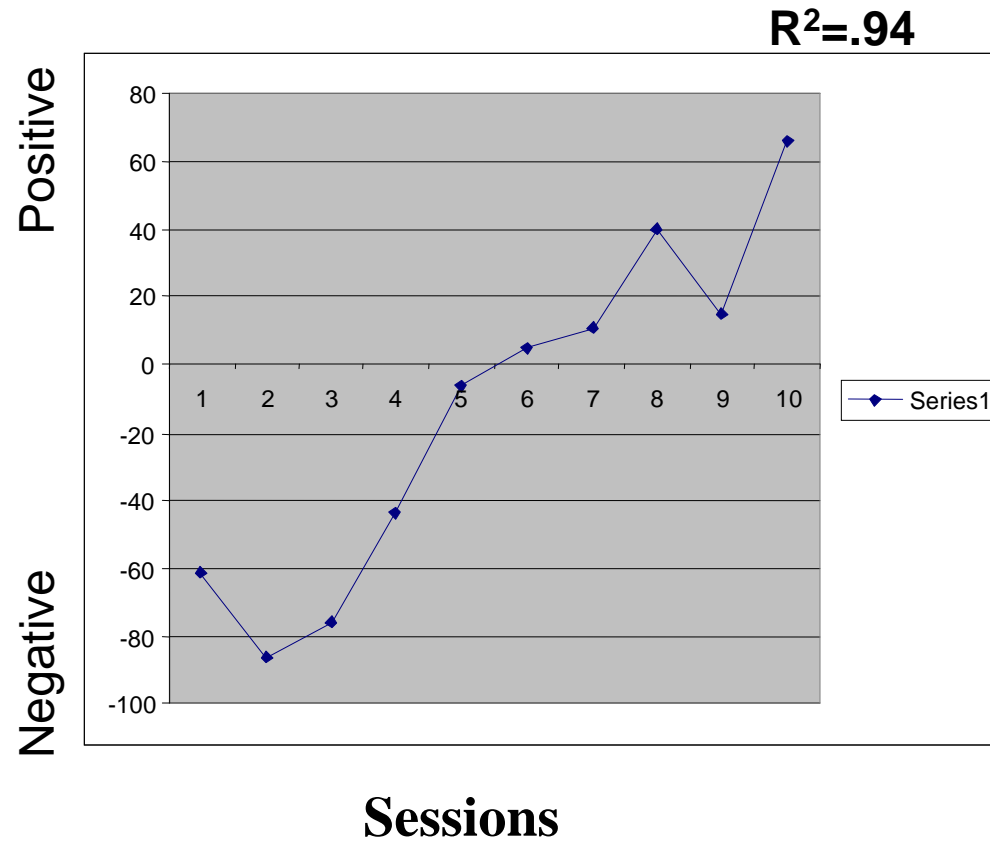

The signature “Snake Wiggle”

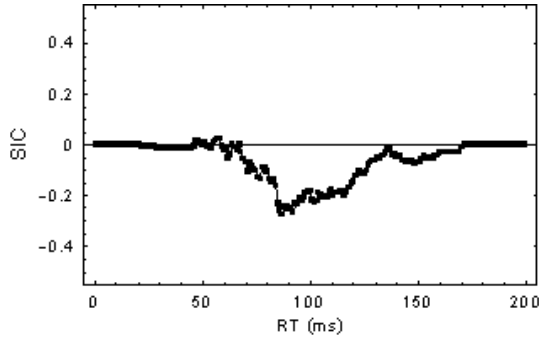

The sum of the area under the curve

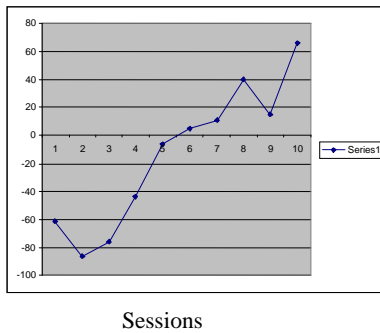

Mean RT trend

Mean RT

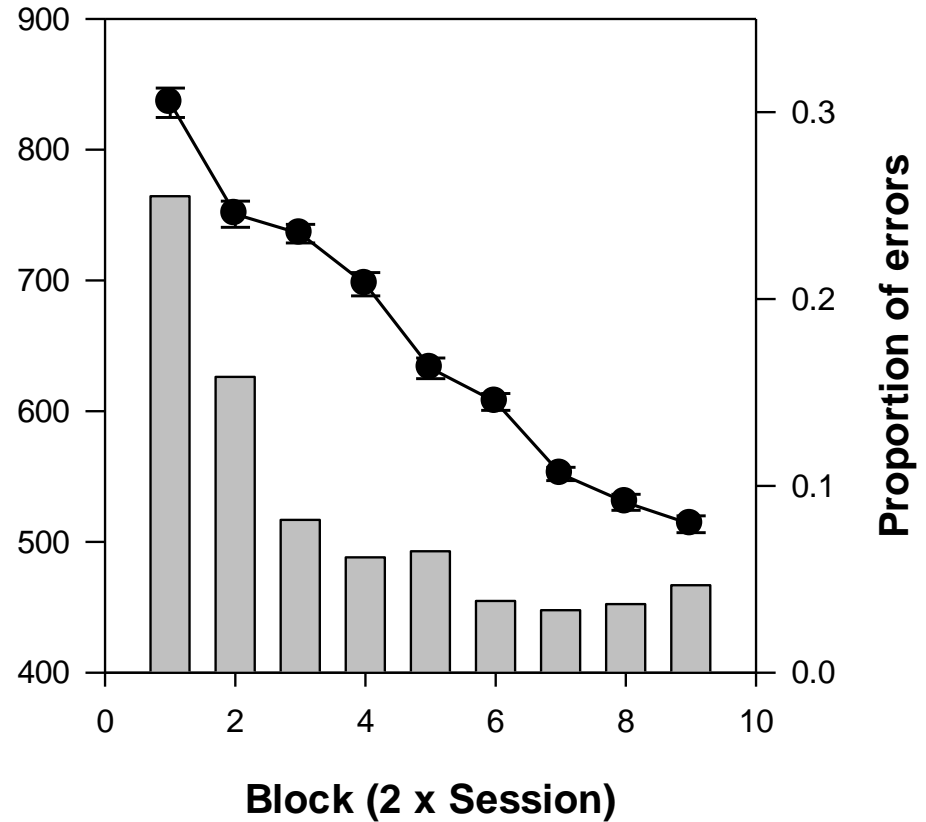

The converging evidence toward holistic processing

- **Let's wiggle:** The SIC function wiggles its way to S-shaped positive function
- **Robustness:** All subjects wiggled
- **Coactivation:** The target signature is Coactive, an indicator of strong holism
- **Performance superiority:** Mean RT decreases, and accuracy improves (superior performance)
- **Introspection:** The verbal reports

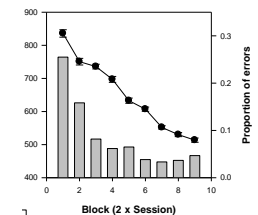
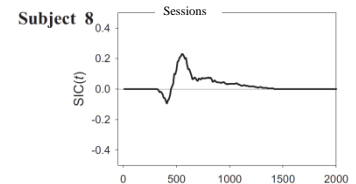
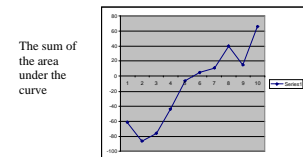
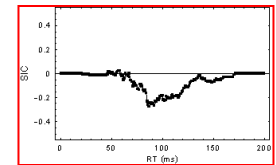

Conclusion

- How strong is the conclusion that a Snake Wiggle signature indicates strong holism?
- Can we make it stronger?

More converging evidence

Conjunctive-rule classification “AND

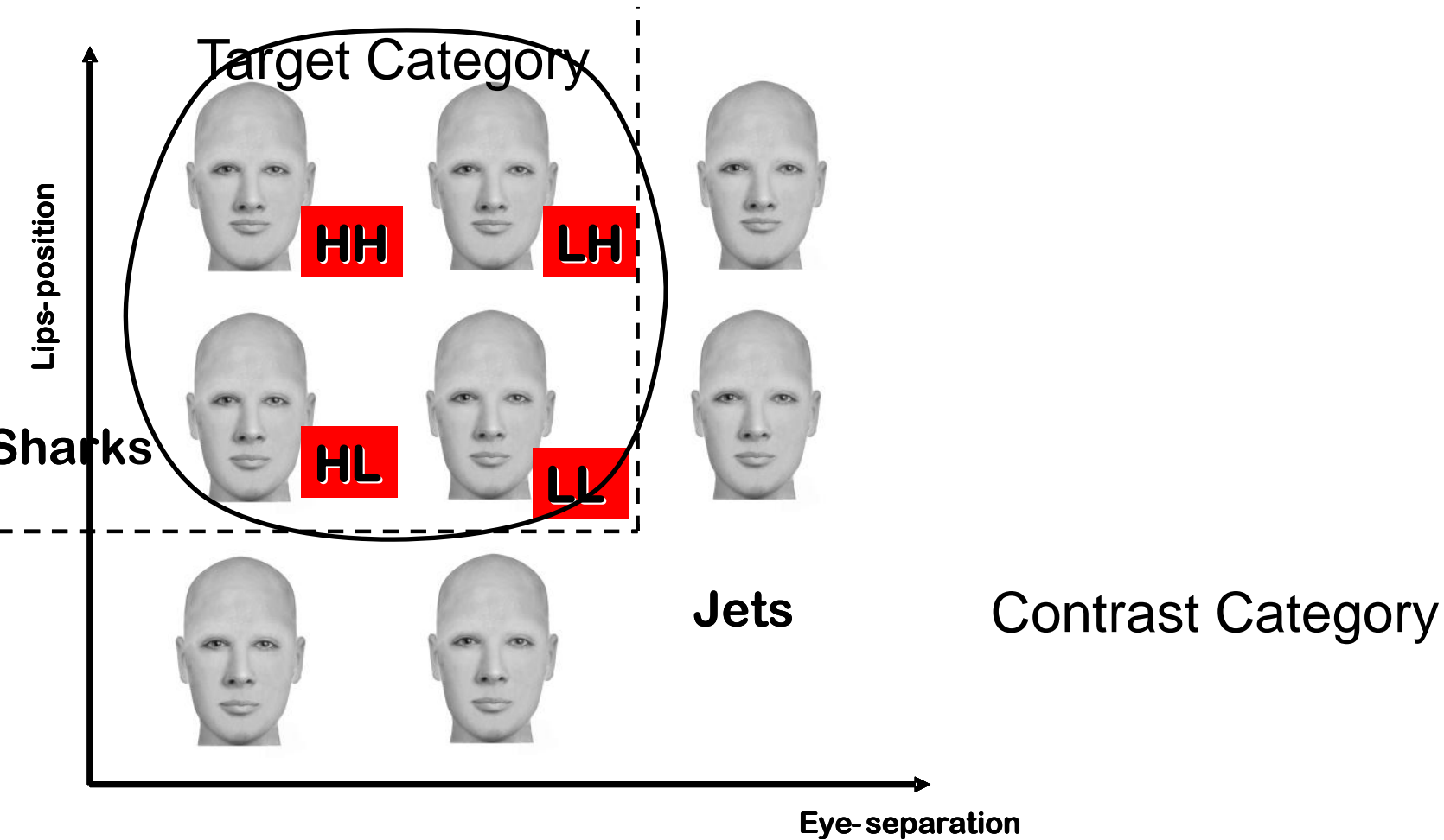

(Fific & Townsend, 2010)

Converging evidence

Conjunctive-rule classification “AND

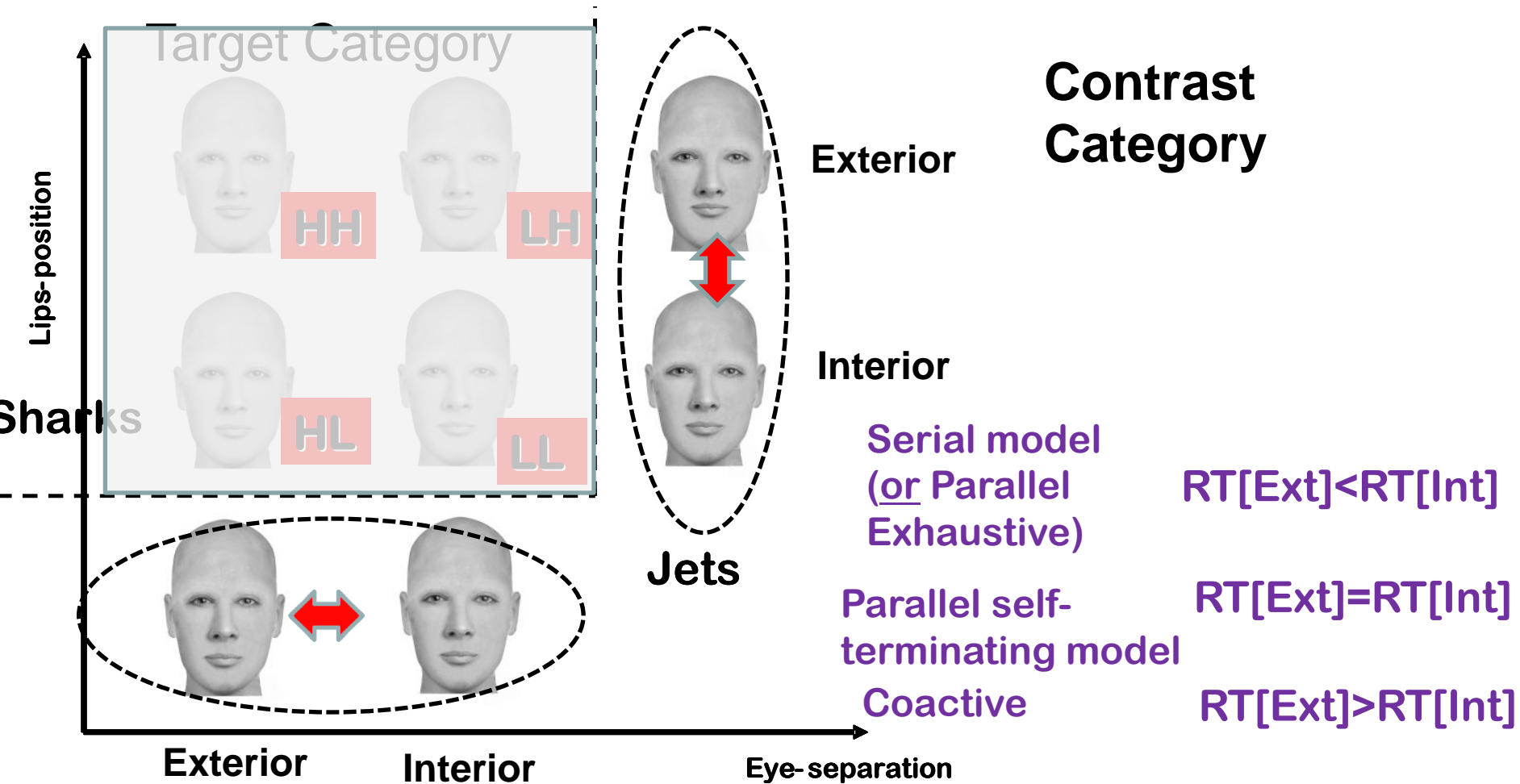

(Fific, Little & Nosofsky, 2010; Psych Review)

Converging evidence

RT[Ext]-RT[Int]

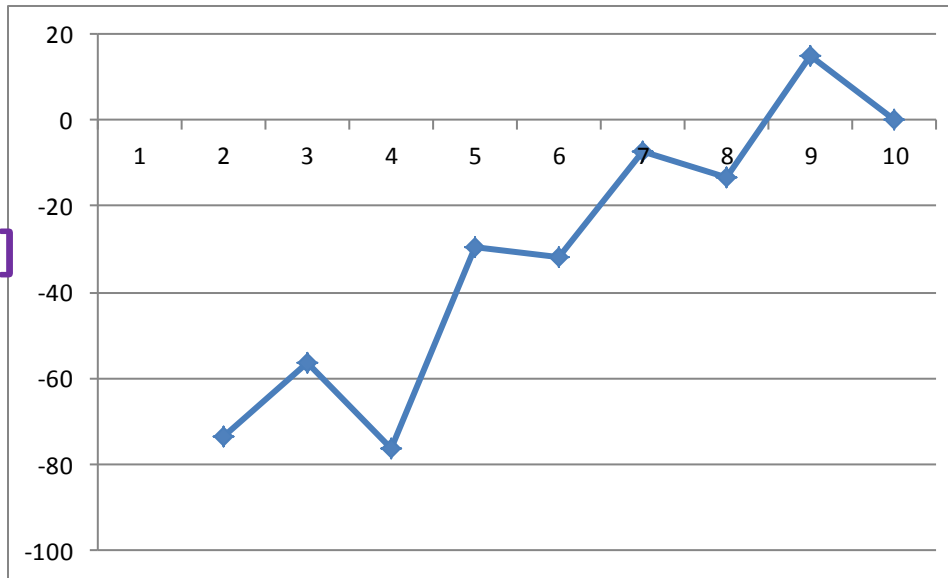

“Coactive”



Snake Wiggle

“Serial or
Parallel Exhaustive”

RT[Ext]-RT[Int]

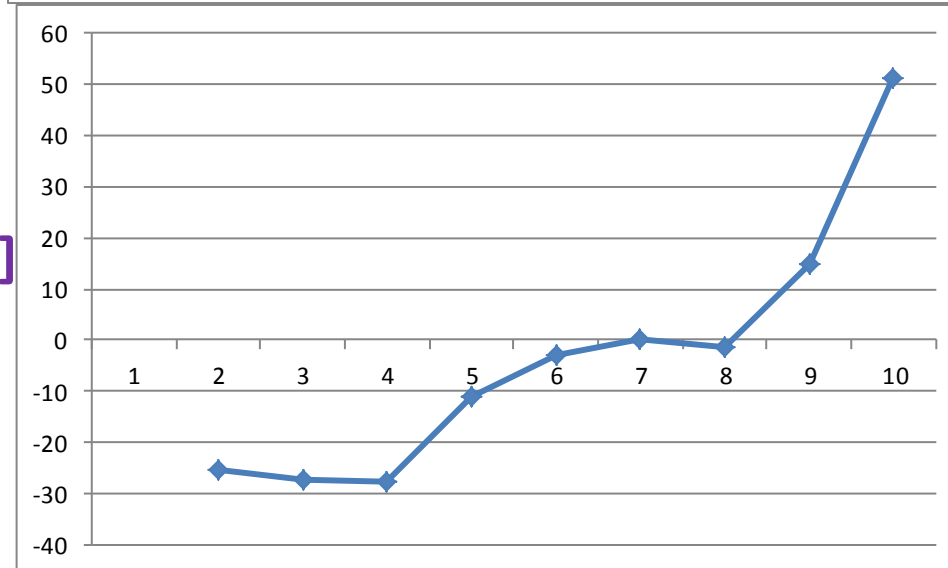

“Coactive”

“Serial or
Parallel Exhaustive”

Cognitive control of Analytic/Holistic Perception?

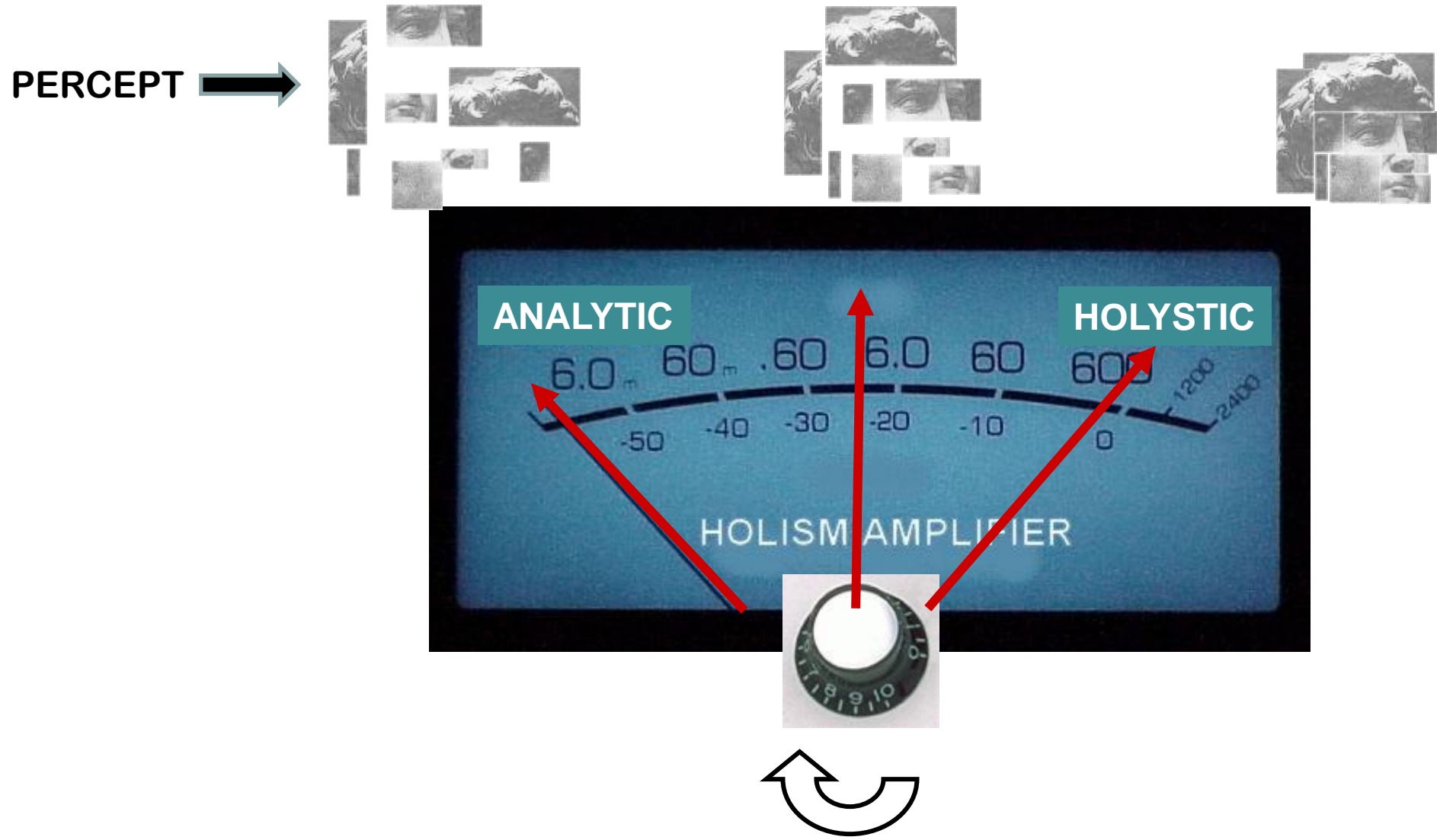

Plausible Model

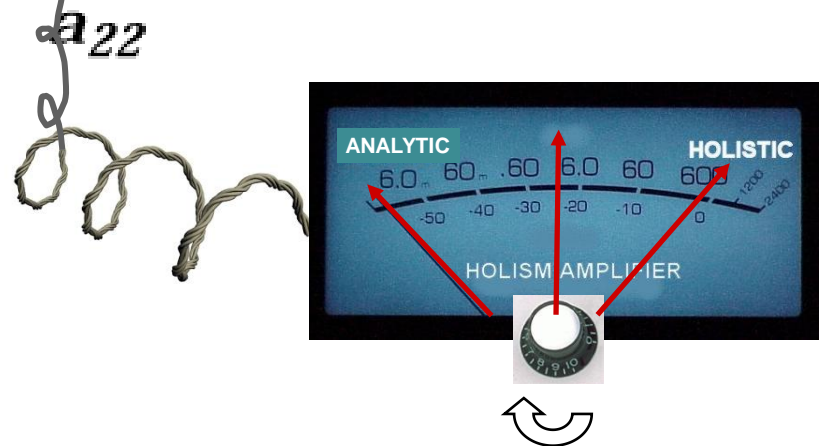
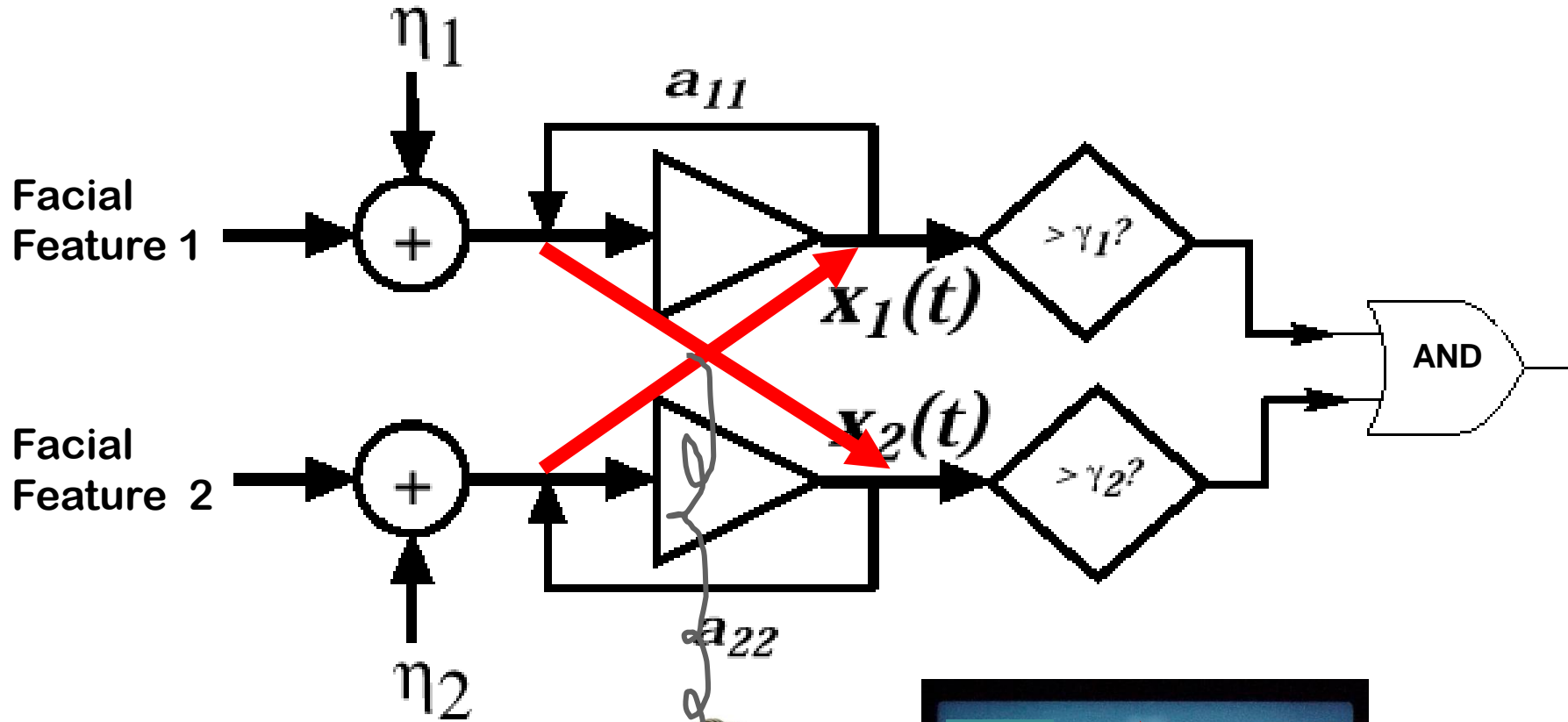

The snake wiggle

- **The snake wiggle is a dynamic signature of holistic perception**
- **The converging evidence from other sources: superiority, robustness and introspection.**
- **The entire stimulus set wiggles.**
- **Plausible trusted models for dynamical evidence accumulation.** (Houpt & Townsend, 2011; Fific & Townsend, 2010; Eidels, Houpt, Altieri & Townsend, 2011)
- **Let's wiggle.**